

The FSB 1107 is related to the FSB 1108. FSB's in-house designer Hartmut Weise has imbued his 'Brakel Lightweight' with the curve of a door in motion. His lever handles for narrow-stile doors were soon joined by the FSB 1177 variant with a return-to-door.

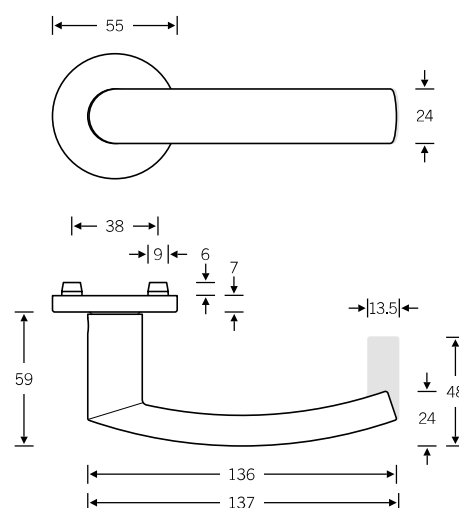
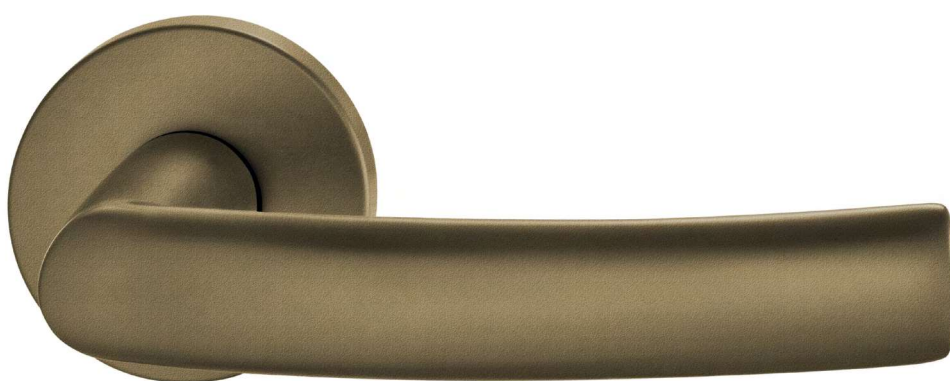

Design: Hartmut Weise

EN 179 model: FSB 1177
Lever handle with return-to-door

Other variants:
– square roses
– oval/angular backplates

Plug-in handle for doors

15 1107

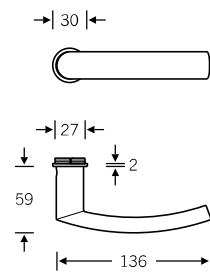

4

Window handle

Plug-in handle for windows

34 1107

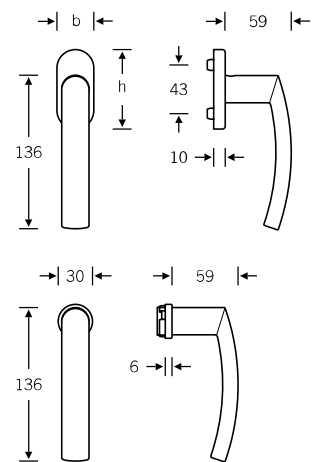
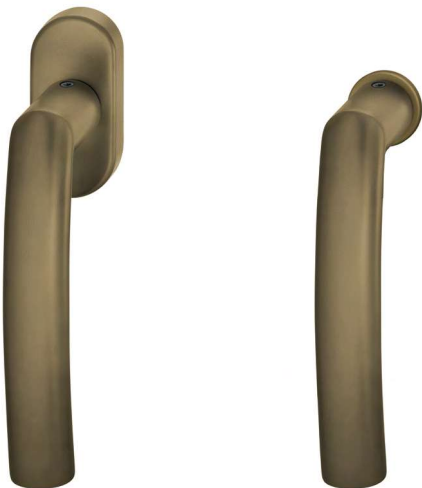

Lever handles for narrow-stile doors

09 1177 (in-line, EN 179)
06 1177 (cranked, EN 179)

Option without return-to-door:
09 1107 (in-line)
06 1107 (cranked)

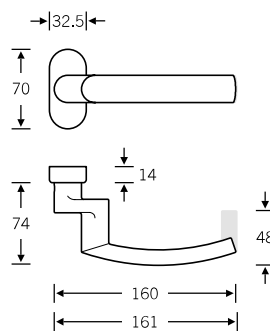
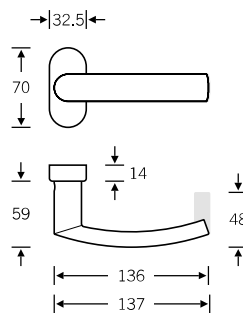

Doorknob for narrow-stile doors

07 0846 (cranked)

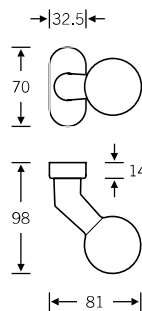

Glass door fitting

13 4223 with 72 1107

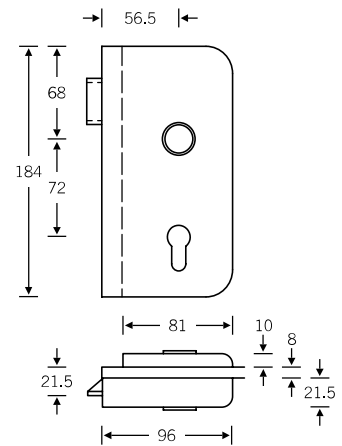

4

Lever/knob sets

Doorknob for flush doors

Knob backplates

Aluminium X = 77 mm
Stainless steel X = 73 mm

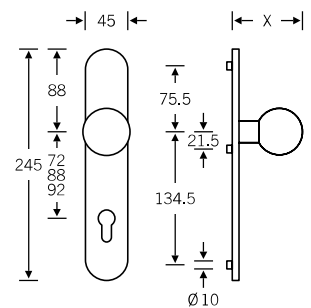
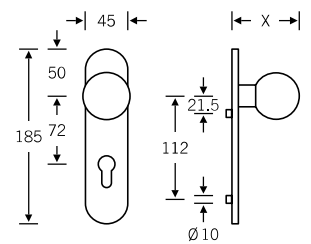
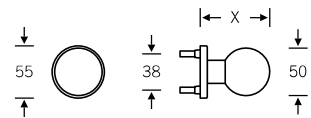

Product codes for the lever/knob sets can be found on the following pages; for individual components, see page 328 ff.

Lever/lever sets

Broad backplate sets available upon request; for flush-fitted roses, see page 536 f.

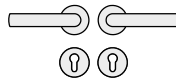

- 12 1107 013 (N)
- 72 1107 613 (R)
- 76 1107 613 (R)
- 79 1177 613 (R)
- 72 1107 614 (L)
- 76 1107 614 (L)
- 79 1177 614 (L)

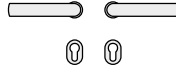

- 15 1107 013 (N)

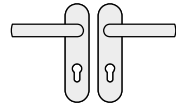

- 12 1107 007 (N)
- 72 1107 607 (R)
- 76 1107 607 (R)
- 79 1177 607 (R)
- 72 1107 608 (L)
- 76 1107 608 (L)
- 79 1177 608 (L)

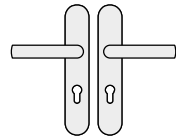

- 12 1107 027 (N)
- 72 1107 627 (R)
- 76 1107 627 (R)
- 79 1177 627 (R)
- 72 1107 628 (L)
- 76 1107 628 (L)
- 79 1177 628 (L)

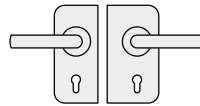

- 13 4223 041 (R) with 10 1107 00500 (N)
- 13 4223 042 (R) with 12 1107 013 (N)
- 13 4223 042 (R) with 72 1107 613 (R)
- 13 4223 051 (L) with 10 1107 00500 (N)
- 13 4223 052 (L) with 12 1107 013 (N)
- 13 4223 052 (L) with 72 1107 614 (L)

Sets for narrow-stile doors

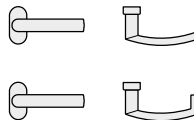

- 09 1107 211
- 09 1107 212
- 09 1177 212
- 09 1177 223 (ILS)

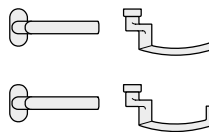

- 06 1107 111
- 06 1107 112
- 06 1177 112
- 06 1107 023 (ILS)
- 06 1177 023 (ILS)



- 07 0846 228 (fixed; aluminium and stainless steel)
- 07 0846 228 (fixed; stainless steel)
- 07 0846 428 (fixed; aluminium)



- 17 1757

Lever/knob sets

Broad backplate sets available upon request;
for flush-fitted roses, see page 536 f.

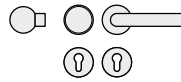

- 12 1107 015 (N)
- 72 1107 615 (R)
- 76 1107 615 (R)
- 79 1177 615 (R)
- 79 1177 619 (ILS)
- 72 1107 616 (L)
- 76 1107 616 (L)
- 79 1177 616 (L)

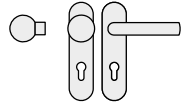

- 12 1107 009 (N)
- 72 1107 609 (R)
- 76 1107 609 (R)
- 79 1177 609 (R)
- 79 1177 611 (ILS)
- 72 1107 610 (L)
- 76 1107 610 (L)
- 79 1177 610 (L)

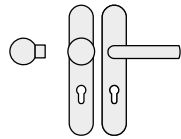

- 12 1107 029 (N)
- 72 1107 629 (R)
- 76 1107 629 (R)
- 79 1177 629 (R)
- 79 1177 631 (ILS)
- 72 1107 630 (L)
- 76 1107 630 (L)
- 79 1177 630 (L)

WC sets

Broad backplate sets available upon request;
for flush-fitted roses, see page 536 f.

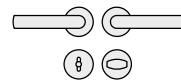

- 12 1107 019 (N)
- 72 1107 619 (R)
- 72 1107 620 (L)

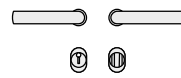

- 15 1107 019 (N)

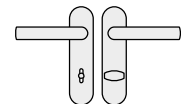

- 12 1107 011 (N)
- 72 1107 611 (R)
- 72 1107 612 (L)

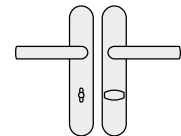

- 12 1107 031 (N)
- 72 1107 631 (R)
- 72 1107 632 (L)

Window handles



- 34 1107 09030 (rose 27 × 62 × 10)
- 34 1107 09039 (rose 32.5 × 70 × 10)
- 34 1107 09034 (rose 25.5 × 60.5 flush-fitted)
- 34 1107 170 (lock adaptor RC 1–6)
- 34 1107 076 (lock adaptor with push-button RC 1–6)
- 34 1107 711 (plug-in handle for timber/metal profiles, Ø 30)
- 34 1107 751 (plug-in handle for PVC profiles, Ø 30)

N = non-handed
R = DIN RH, opening inwards
L = DIN LH, opening inwards
ILS = inactive-leaf set

Female handles
Plug-in handle for doors
FSB ASL®
FSB AGL®
FS heavy-duty fitting
EN 179 heavy-duty fitting

For bearings, see page 52 ff.