

Our in-house designer Hartmut Weise was musing over what it is that gives the 'Frankfurt model' and 'Wittgenstein's handle' their particular appeal. It was their 'unpretentious look,' he concluded. He then set out to offer the market an unostentatious design that was at the very least on a par with them. The upshot was the FSB 1108 – a round tube coupled with a mitred grip section with an oval cross-section. Could this be the 'Brakel model'?

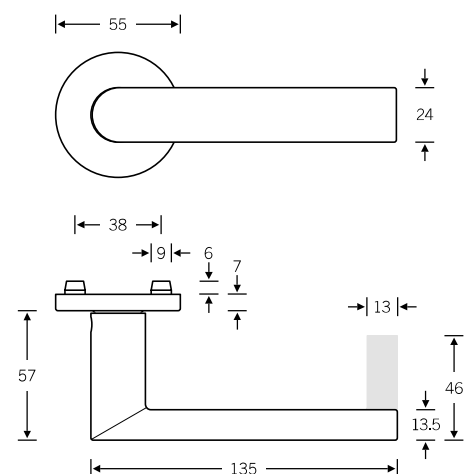

Design: Hartmut Weise

EN 179 model: FSB 1178  
Lever handle with return-to-door

Other variants:  
– square roses  
– oval/angular backplates

Plug-in handle for doors

15 1108

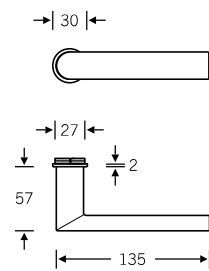

4

Window handle

Plug-in handle for windows

34 1108

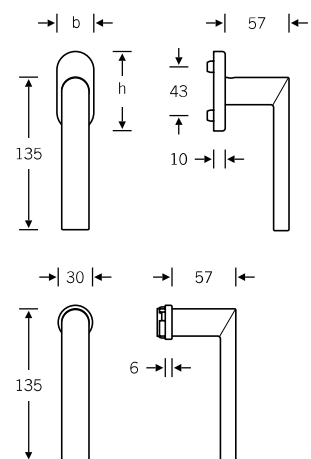

Custom-coordinated lifting/sliding door handle available upon request, see page 10

Lever handles for narrow-stile doors

09 1178 (in-line, EN 179)  
06 1178 (cranked, EN 179)

Option without return-to-door:  
09 1108 (in-line)  
06 1108 (cranked)

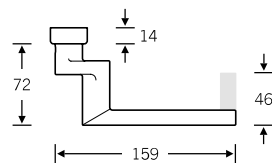
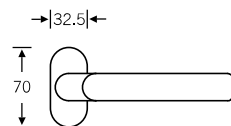
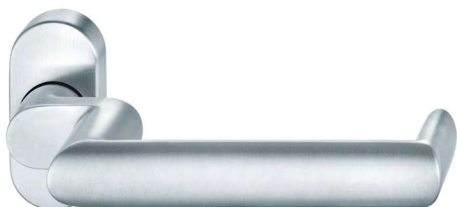
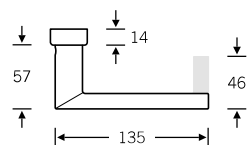
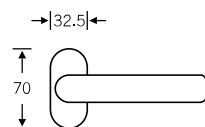

Doorknob for narrow-stile doors

07 0846 (cranked)

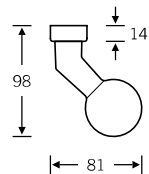
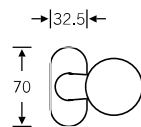

## Glass door fitting

13 4223 with 72 1108

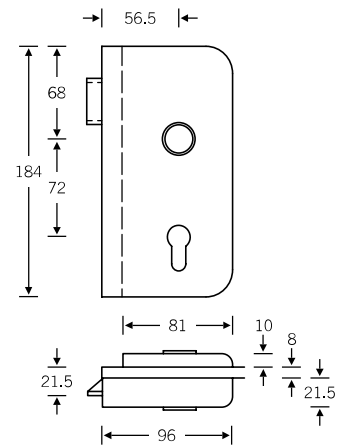

4

## Lever/knob sets

Doorknob for flush doors

Knob backplates

Aluminium X = 77 mm  
Stainless steel X = 73 mm

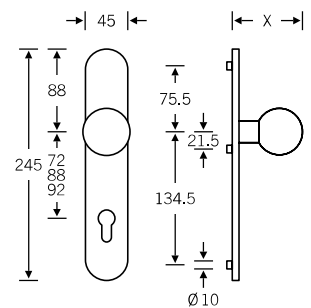
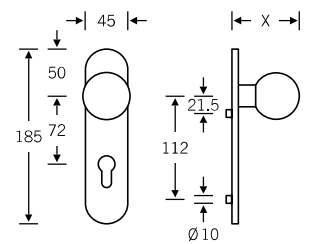
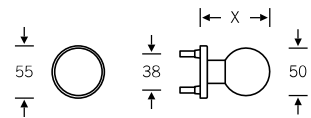

Product codes for the lever/knob sets can be found on the following pages; for individual components, see page 328 ff.

## Lever/lever sets

Broad backplate sets available upon request; for flush-fitted roses, see page 536 f.

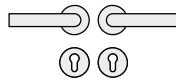

- 12 1108 013 (N)
- 72 1108 613 (R)
- 76 1108 613 (R)
- 79 1178 613 (R)
- 72 1108 614 (L)
- 76 1108 614 (L)
- 79 1178 614 (L)

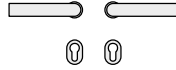

- 15 1108 013 (N)

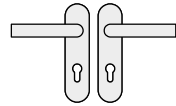

- 12 1108 007 (N)
- 72 1108 607 (R)
- 76 1108 607 (R)
- 79 1178 607 (R)
- 72 1108 608 (L)
- 76 1108 608 (L)
- 79 1178 608 (L)

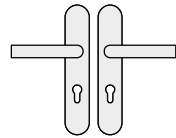

- 12 1108 021 (N)
- 72 1108 627 (R)
- 76 1108 627 (R)
- 79 1178 627 (R)
- 72 1108 628 (L)
- 76 1108 628 (L)
- 79 1178 628 (L)

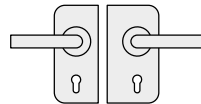

- 13 4223 041 (R) with 10 1108 00500 (N)
- 13 4223 042 (R) with 12 1108 013 (N)
- 13 4223 042 (R) with 72 1108 613 (R)
- 13 4223 051 (L) with 10 1108 00500 (N)
- 13 4223 052 (L) with 12 1108 013 (N)
- 13 4223 052 (L) with 72 1108 614 (L)

## Sets for narrow-stile doors

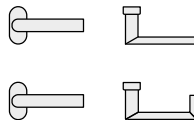

- 09 1108 211
- 09 1108 212
- 09 1178 212
- 09 1178 223 (ILS)

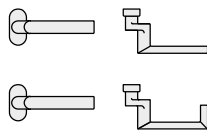

- 06 1108 111
- 06 1108 112
- 06 1178 112
- 06 1108 023 (ILS)
- 06 1178 023 (ILS)



- 07 0846 228 (fixed; aluminium and stainless steel)
- 07 0846 228 (fixed; stainless steel)
- 07 0846 428 (fixed; aluminium)



- 17 1757

## Lever/knob sets

Broad backplate sets available upon request; for flush-fitted roses, see page 536 f.

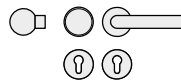

- 12 1108 015 (N)
- 72 1108 615 (R)
- 76 1108 615 (R)
- 79 1178 615 (R)
- 79 1178 619 (ILS)
- 72 1108 616 (L)
- 76 1108 616 (L)
- 79 1178 616 (L)

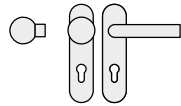

- 12 1108 009 (N)
- 72 1108 609 (R)
- 76 1108 609 (R)
- 79 1178 609 (R)
- 79 1178 611 (ILS)
- 72 1108 610 (L)
- 76 1108 610 (L)
- 79 1178 610 (L)

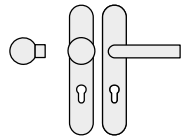

- 12 1108 029 (N)
- 72 1108 629 (R)
- 76 1108 629 (R)
- 79 1178 629 (R)
- 79 1178 631 (ILS)
- 72 1108 630 (L)
- 76 1108 630 (L)
- 79 1178 630 (L)

## WC sets

Broad backplate sets available upon request; for flush-fitted roses, see page 536 f.

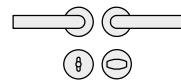

- 12 1108 019 (N)
- 72 1108 619 (R)
- 72 1108 620 (L)

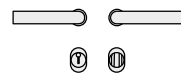

- 15 1108 019 (N)

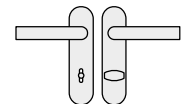

- 12 1108 011 (N)
- 72 1108 611 (R)
- 72 1108 612 (L)

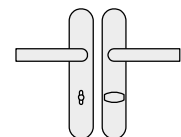

- 12 1108 031 (N)
- 72 1108 631 (R)
- 72 1108 632 (L)

## Window handles

Custom-coordinated lifting/sliding door handle available upon request, see page 10



- 34 1108 09030 (rose 27 × 62 × 10)
- 34 1108 09039 (rose 32.5 × 70 × 10)
- 34 1108 09034 (rose 25.5 × 60.5 flush-fitted)
- 34 1108 170 (lock adaptor RC 1–6)
- 34 1108 076 (lock adaptor with push-button RC 1–6)
- 34 1108 711 (plug-in handle for timber/metal profiles, Ø 30)
- 34 1108 751 (plug-in handle for PVC profiles, Ø 30)
- 34 1108 714 (plug-in handle, lock adaptor RC 1–6)
- 34 1108 717 (plug-in handle with push-button RC 1–6)

N = non-handed  
 R = DIN RH, opening inwards  
 L = DIN LH, opening inwards  
 ILS = inactive-leaf set

Female handles  
 Plug-in handle for doors  
 FSB ASL®  
 FSB AGL®  
 FS heavy-duty fitting  
 EN 179 heavy-duty fitting

For bearings, see page 52 ff.