

In the autumn of 1996, Düsseldorf-based interior designer Heike Falkenberg asked FSB to recreate an old handle design for a renovation job. Using the sketch she submitted, FSB's developers milled a prototype out of the FSB 1076 handle. It was recently reinterpreted by giving it a square rose.

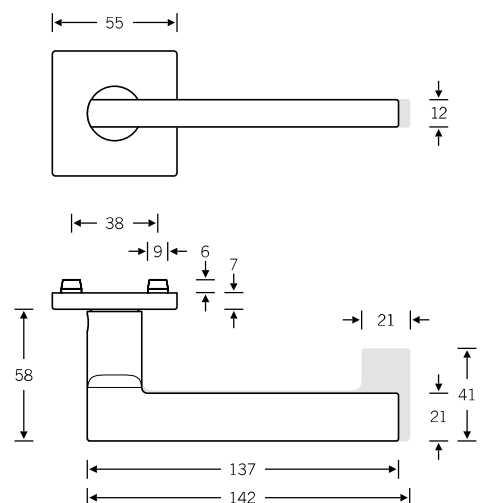
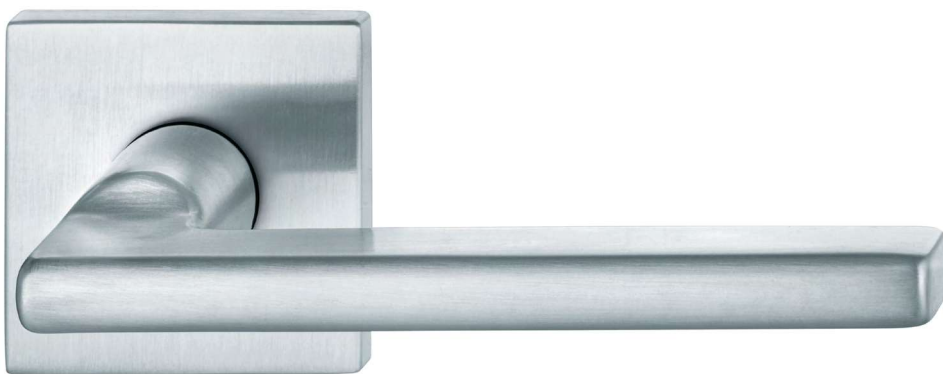

Design: Heike Falkenberg

EN 179 model: FSB 1031
Lever handle with return-to-door

Other variants:
– round roses
– oval/angular backplates

Plug-in handle for doors

15 1035

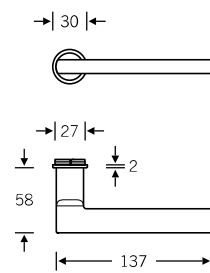

4

Window handle

Plug-in handle for windows

34 1035

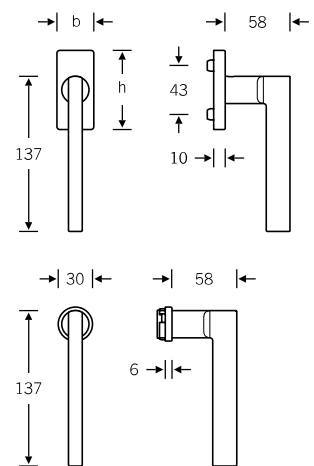

Custom-coordinated lifting/sliding door handle available upon request, see page 10

Lever handles for narrow-stile doors

09 1031 (in-line, EN 179)
06 1031 (cranked, EN 179)

Option without return-to-door:
09 1035 (in-line)
06 1035 (cranked)



Model 09 1031



Model 09 1035



Model 06 1031



Model 06 1035

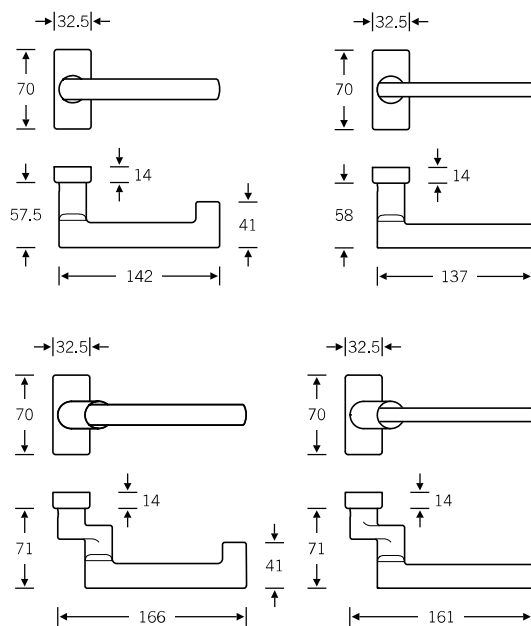

Doorknob for narrow-stile doors

07 0812 (cranked)

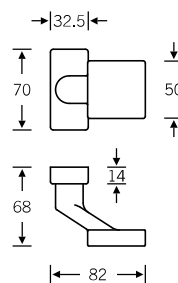

Glass door fitting

13 4220 with 10 1035

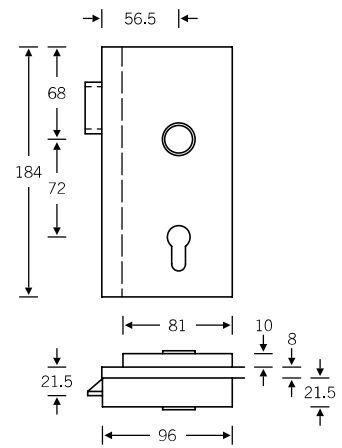

4

Lever/knob sets

Doorknob for flush doors

Knob backplates

Aluminium $\varnothing = 50$
Stainless steel $\varnothing = 55$

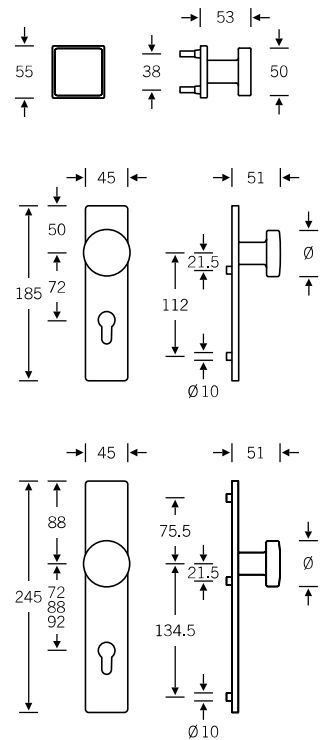

Product codes for the lever/knob sets can be found on the following pages; for individual components, see page 328 ff.

Lever/lever sets

Broad backplate sets available upon request; for flush-fitted roses, see page 536 f.

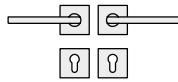

- 12 1035 041 (N)
- 72 1035 641 (R)
- 76 1035 639 (R)*
- 79 1031 639 (R)
- 72 1035 642 (L)
- 76 1035 640 (L)*
- 79 1031 640 (L)

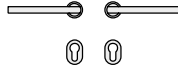

- 15 1035 013 (N)

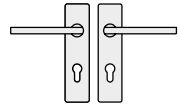

- 12 1035 001 (N)
- 72 1035 601 (R)
- 76 1035 601 (R)*
- 79 1031 601 (R)
- 72 1035 602 (L)
- 76 1035 602 (L)*
- 79 1031 602 (L)

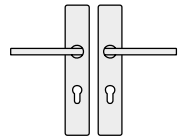

- 12 1035 021 (N)
- 72 1035 621 (R)
- 76 1035 621 (R)*
- 79 1031 621 (R)
- 72 1035 622 (L)
- 76 1035 622 (L)*
- 79 1031 622 (L)

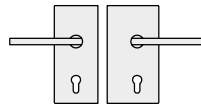

- 13 4220 041 (R) with 10 1035 00500 (N)
- 13 4220 042 (R) with 12 1035 041 (N)
- 13 4220 042 (R) with 72 1035 641 (R)
- 13 4220 090** with 76 1035 639 (R)
- 13 4220 090** with 79 1031 939 (N)
- 13 4220 051 (L) with 10 1035 00500 (N)
- 13 4220 052 (L) with 12 1035 041 (N)
- 13 4220 052 (L) with 72 1035 642 (L)
- 13 4220 090** with 76 1035 640 (L)

Sets for narrow-stile doors

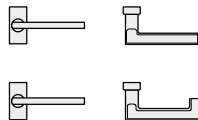

- 09 1035 271
- 09 1035 272
- 09 1031 272
- 09 1031 273 (ILS)*

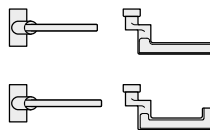

- 06 1035 171
- 06 1035 172*
- 06 1031 172
- 06 1035 073 (ILS)*
- 06 1031 073 (ILS)



- 07 0812 229 (fixed; aluminium and stainless steel)
- 07 0812 229 (fixed; stainless steel)
- 07 0812 429 (fixed; aluminium)



- 17 1778

* In stainless steel only; for ÖNORM compliance also in aluminium

** Fire safety and EN 179 variants available only in stainless steel; for variants, see page 508

Lever/knob sets

Broad backplate sets available upon request; for flush-fitted roses, see page 536 f.

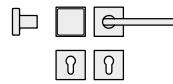

- | | |
|-------------------|------------------|
| 12 1035 043 (N) | 72 1035 644 (L) |
| 72 1035 643 (R) | 76 1035 642 (L)* |
| 76 1035 641 (R)* | 79 1031 642 (L) |
| 79 1031 641 (R) | |
| 79 1031 643 (ILS) | |

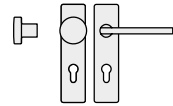

- | | |
|-------------------|------------------|
| 12 1035 003 (N) | 72 1035 604 (L) |
| 72 1035 603 (R) | 76 1035 604 (L)* |
| 76 1035 603 (R)* | 79 1031 604 (L) |
| 79 1031 603 (R) | |
| 79 1031 605 (ILS) | |

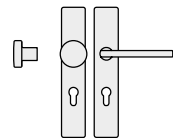

- | | |
|-------------------|------------------|
| 12 1035 023 (N) | 72 1035 624 (L) |
| 72 1035 623 (R) | 76 1035 624 (L)* |
| 76 1035 623 (R)* | 79 1031 624 (L) |
| 79 1031 623 (R) | |
| 79 1031 625 (ILS) | |

WC sets

Broad backplate sets available upon request; for flush-fitted roses, see page 536 f.

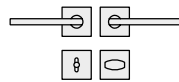

- | | |
|-----------------|-----------------|
| 12 1035 045 (N) | 72 1035 646 (L) |
| 72 1035 645 (R) | |

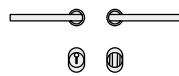

- | |
|-----------------|
| 15 1035 019 (N) |
|-----------------|

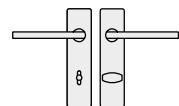

- | | |
|-----------------|-----------------|
| 12 1035 005 (N) | 72 1035 606 (L) |
| 72 1035 605 (R) | |

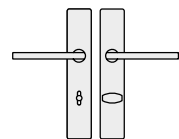

- | | |
|-----------------|-----------------|
| 12 1035 025 (N) | 72 1035 626 (L) |
| 72 1035 625 (R) | |

Window handles

Custom-coordinated lifting/sliding door handle available upon request, see page 10

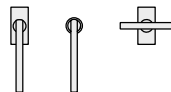

- 34 1035 09032 (rose 27 × 62 × 10)
- 34 1035 09040 (rose 32.5 × 70 × 10)
- 34 1035 09036 (rose 25.5 × 60.5 flush-fitted)
- 34 1035 180 (lock adaptor RC 1–6)
- 34 1035 086 (lock adaptor with push-button RC 1–6)
- 34 1035 711 (plug-in handle for timber/metal profiles, Ø 30)
- 34 1035 751 (plug-in handle for PVC profiles, Ø 30)
- 34 3784 (tee handle for window)

N = non-handed
 R = DIN RH, opening inwards
 L = DIN LH, opening inwards
 ILS = inactive-leaf set

Female handles
 Plug-in handle for doors
 FSB ASL®

FSB AGL®
 FS heavy-duty fitting
 EN 179 heavy-duty fitting

For bearings, see page 52 ff.