

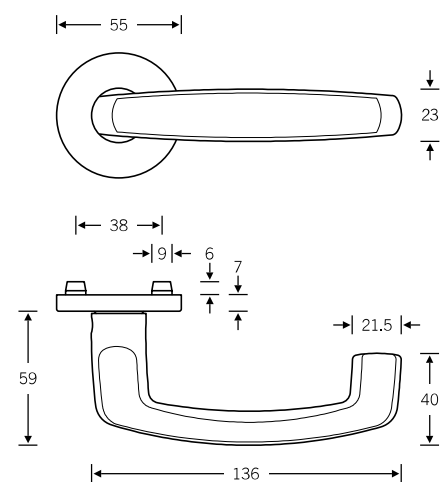

The process of creating the FSB 1159 began for Laurids and Manfred Ortner with a comparative analysis of lever handle models old and new. In the end they authored a moulded-to-the-hand design, the transitions and flowing surfaces of which impart a sense of holding something trusted and familiar in the hand.



Design: Laurids and Manfred Ortner

 EN 179 model:  
 Lever handle with return-to-door

Other variants:  
 – square roses  
 – oval/angular backplates

Plug-in handle for doors

15 1159

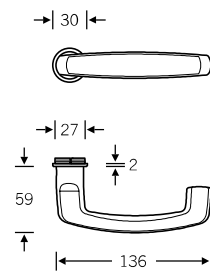

4

Window handle

Plug-in handle for windows

34 1159

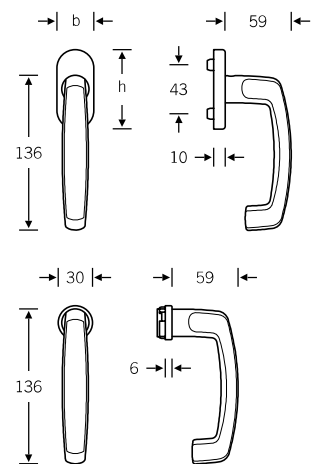

Custom-coordinated lifting/sliding door handle available upon request, see page 10

Lever handles for narrow-stile doors

09 1159 (in-line, EN 179)  
06 1159 (cranked, EN 179)

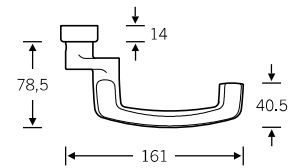
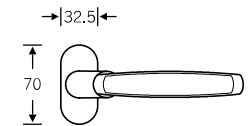
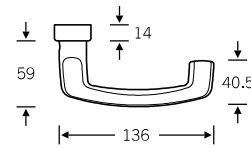
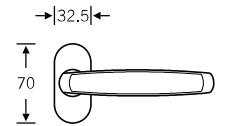

Doorknob for narrow-stile doors

07 0809 (cranked)

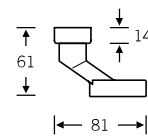
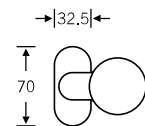

## Glass door fitting

13 4223 with 10 1159

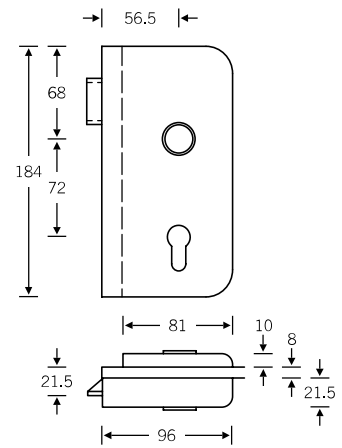

4

## Lever/knob sets

Doorknob for flush doors

Knob backplates

Aluminium  $\varnothing = 50$   
Stainless steel  $\varnothing = 55$

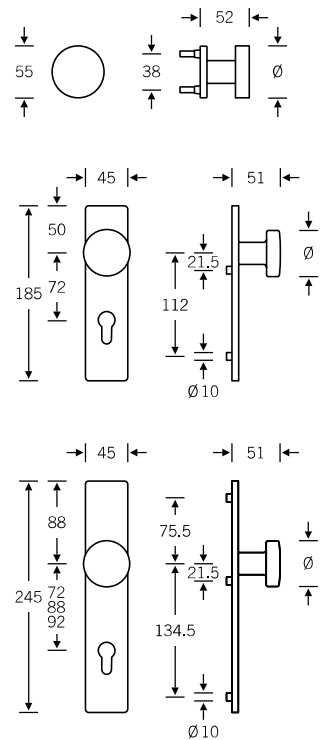



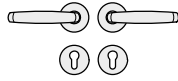

Product codes for the lever/knob sets can be found on the following pages; for individual components, see page 328 ff.

## Lever/lever sets

Broad backplate sets available upon request; for flush-fitted roses, see page 386 f.





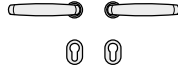

 12 1159 013 (N)  
 72 1159 613 (R)  
 79 1159 613 (R)

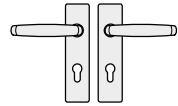

 72 1159 614 (L)  
 79 1159 614 (L)







 15 1159 013 (N)



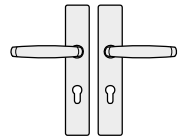

 12 1159 001 (N)  
 72 1159 601 (R)  
 79 1159 601 (R)



 72 1159 602 (L)  
 79 1159 602 (L)



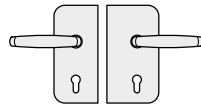

 12 1159 021 (N)  
 72 1159 621 (R)  
 79 1159 621 (R)

 72 1159 622 (L)  
 79 1159 622 (L)





 13 4223 041 (R) with  
 10 1159 00500 (N)  
 13 4223 042 (R) with  
 12 1159 013 (N)  
 13 4223 042 (R) with  
 72 1159 613 (R)

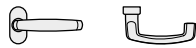

 13 4223 051 (L) with  
 10 1159 00500 (N)  
 13 4223 052 (L) with  
 12 1159 013 (N)  
 13 4223 052 (L) with  
 72 1159 614 (L)

## Sets for narrow-stile doors



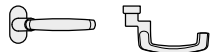

 09 1159 211  
 09 1159 212\*  
 09 1159 223\* (ILS)



 06 1159 111  
 06 1159 112\*

 06 1159 023 (ILS)\*



 07 0809 228 (fixed; aluminium and stainless steel)  
 07 0809 228 (fixed; stainless steel)  
 07 0809 428 (fixed; aluminium)



17 1757

Fire safety fittings  
only in stainless steel

\* In stainless steel only, pursuant to DIN 18273;  
for ÖNORM compliance also in aluminium

## Lever/knob sets

Broad backplate sets available upon request

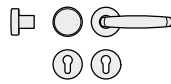

- 12 1159 017 (N)
- 72 1159 617 (R)
- 79 1159 617 (R)
- 79 1159 619 (ILS)
- 72 1159 618 (L)
- 79 1159 618 (L)

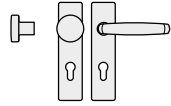

- 12 1159 003 (N)
- 72 1159 603 (R)
- 79 1159 603 (R)
- 79 1159 605 (ILS)
- 72 1159 604 (L)
- 79 1159 604 (L)

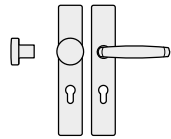

- 12 1159 023 (N)
- 72 1159 623 (R)
- 79 1159 623 (R)
- 79 1159 625 (ILS)
- 72 1159 624 (L)
- 79 1159 624 (L)

## WC sets

Broad backplate sets available upon request;  
for flush-fitted roses, see page 386 f.

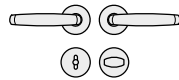

- 12 1159 019 (N)
- 72 1159 619 (R)
- 72 1159 620 (L)

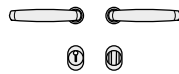

- 15 1159 019 (N)

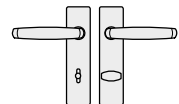

- 12 1159 005 (N)
- 72 1159 605 (R)
- 72 1159 606 (L)

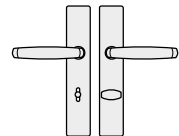

- 12 1159 025 (N)
- 72 1159 625 (R)
- 72 1159 626 (L)

## Window handles

Custom-coordinated lifting/sliding door  
handle available upon request, see page 10



- 34 1159 09030 (rose 27 × 62 × 10)
- 34 1159 09039 (rose 32.5 × 70 × 10)
- 34 1159 09034 (rose 25.5 × 60.5 flush-fitted)
- 34 1159 170 (lock adaptor RC 1–6)
- 34 1159 076 (lock adaptor with push-button RC 1–6)
- 34 1159 711 (plug-in handle for timber/metal profiles, Ø 30)
- 34 1159 751 (plug-in handle for PVC profiles, Ø 30)

N = non-handed  
R = DIN RH, opening inwards  
L = DIN LH, opening inwards  
ILS = inactive-leaf set

Female handles  
Plug-in handle for doors  
FSB ASL®  
FSB AGL®  
FS heavy-duty fitting  
EN 179 heavy-duty fitting

For bearings, see page 52 ff.