

FSB pays tribute to the revered Ludwig Mies van der Rohe with this design. The FSB 1267 is more than just a replica of an original Mies van der Rohe lever handle, however. While retaining the formal thrust of its forebears, our interpretation also conforms to present-day standards and the requirements of modern architecture – now in stainless steel.

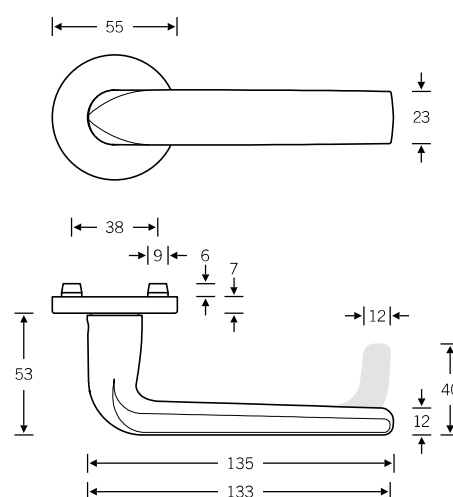

Design: Hartmut Weise

EN 179 model: FSB 1268  
Lever handle with return-to-door

Other variants:  
– square roses  
– oval/angular backplates

Plug-in handle for doors

15 1267

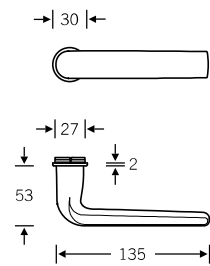

4

Window handle

Plug-in handle for windows

34 1267

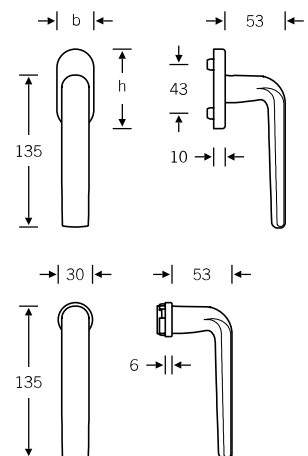

Custom-coordinated lifting/sliding door handle available upon request, see page 10

Lever handles for narrow-stile doors

09 1268 (in-line, EN 179)  
06 1268 (cranked, EN 179)

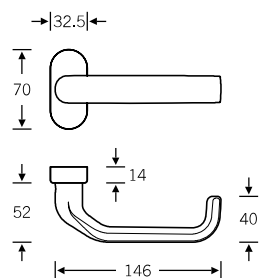
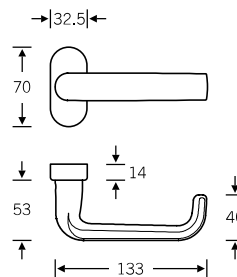

Doorknob for narrow-stile doors

07 0809 (cranked)

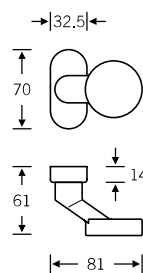

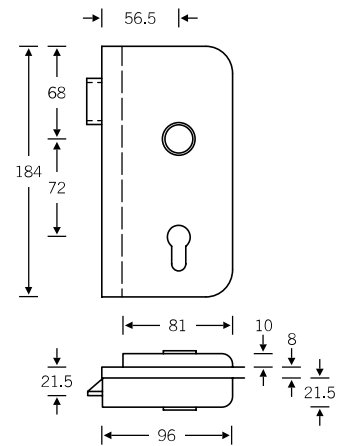

Lever/knob sets

Doorknob for flush doors

- Aluminium  $\varnothing = 50$
- Stainless steel  $\varnothing = 55$
- Bronze  $\varnothing = 50$

Knob backplates

- Aluminium X = 77 mm
- Stainless steel X = 73 mm
- Bronze X = 72 mm

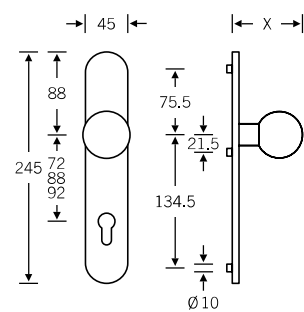
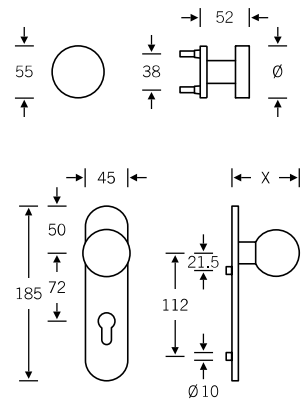
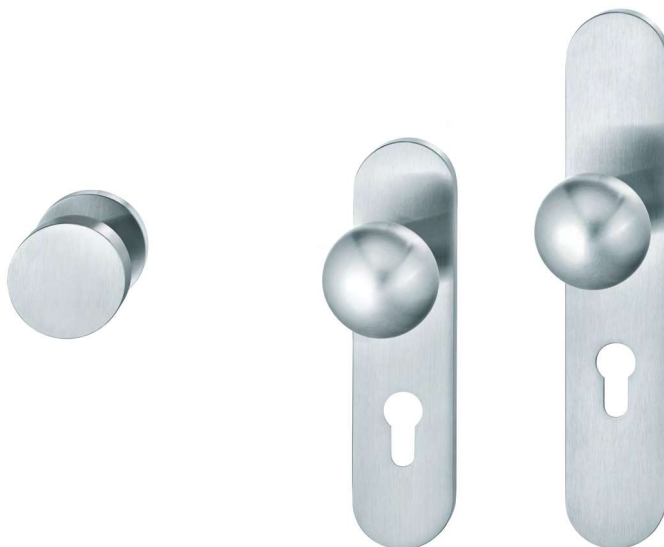

Product codes for the lever/knob sets can be found on the following pages; for individual components, see page 328 ff.

## Lever/lever sets

Broad backplate sets available upon request; for flush-fitted roses, see page 536 f.

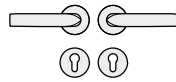

- 12 1267 013 (N)
- 72 1267 613 (R)
- 76 1267 613 (R)
- 79 1268 613 (R)
- 72 1267 614 (L)
- 76 1267 614 (L)
- 79 1268 614 (L)

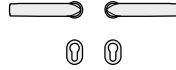

- 15 1267 013 (N)

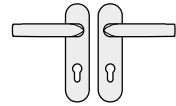

- 12 1267 007 (N)
- 72 1267 607 (R)
- 76 1267 607 (R)
- 79 1268 607 (R)
- 72 1267 608 (L)
- 76 1267 608 (L)
- 79 1268 608 (L)

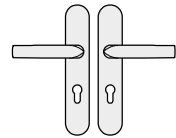

- 12 1267 027 (N)
- 72 1267 627 (R)
- 76 1267 627 (R)
- 79 1268 627 (R)
- 72 1267 628 (L)
- 76 1267 628 (L)
- 79 1268 628 (L)

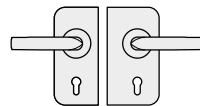

- 13 4223 041 (R) with 10 1267 00500 (N)
- 13 4223 042 (R) with 12 1267 013 (N)
- 13 4223 042 (R) with 72 1267 613 (R)
- 13 4223 051 (L) with 10 1267 00500 (N)
- 13 4223 052 (L) with 12 1267 013 (N)
- 13 4223 052 (L) with 72 1267 614 (L)

## Sets for narrow-stile doors



- 09 1268 211
- 09 1268 212
- 09 1268 223 (ILS)

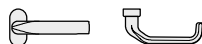

- 06 1268 111
- 06 1268 112
- 06 1268 023 (ILS)



- 07 0809 228 (fixed; aluminium and stainless steel)
- 07 0809 228 (fixed; stainless steel)
- 07 0809 428 (fixed; aluminium)

For set in bronze with knob 07 0846, see page 481



- 17 1757

## Lever/knob sets

Broad backplate sets available upon request; for flush-fitted roses, see page 536 f.

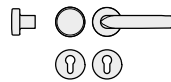

- |                   |                   |
|-------------------|-------------------|
| 12 1267 017 (N)   | 72 1267 618 (L)   |
| 72 1267 617 (R)   | 76 1267 618 (L)   |
| 76 1267 617 (R)   | 79 1268 618 (L)   |
| 79 1268 617 (R)   | 79 1268 619 (ILS) |
| 79 1268 619 (ILS) |                   |

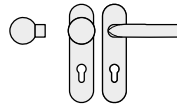

- |                   |                   |
|-------------------|-------------------|
| 12 1267 009 (N)   | 72 1267 610 (L)   |
| 72 1267 609 (R)   | 76 1267 610 (L)   |
| 76 1267 609 (R)   | 79 1268 610 (L)   |
| 79 1268 609 (R)   | 79 1268 611 (ILS) |
| 79 1268 611 (ILS) |                   |

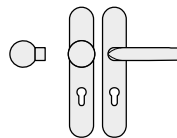

- |                   |                   |
|-------------------|-------------------|
| 12 1267 029 (N)   | 72 1267 630 (L)   |
| 72 1267 629 (R)   | 76 1267 630 (L)   |
| 76 1267 629 (R)   | 79 1268 630 (L)   |
| 79 1268 629 (R)   | 79 1268 631 (ILS) |
| 79 1268 631 (ILS) |                   |

## WC sets

Broad backplate sets available upon request; for flush-fitted roses, see page 536 f.

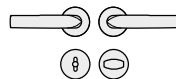

- |                 |                 |
|-----------------|-----------------|
| 12 1267 019 (N) | 72 1267 620 (L) |
| 72 1267 619 (R) |                 |

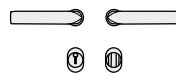

- |                 |
|-----------------|
| 15 1267 019 (N) |
|-----------------|

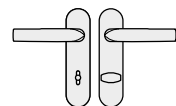

- |                 |                 |
|-----------------|-----------------|
| 12 1267 011 (N) | 72 1267 612 (L) |
| 72 1267 611 (R) |                 |

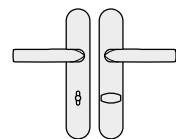

- |                 |                 |
|-----------------|-----------------|
| 12 1267 031 (N) | 72 1267 632 (L) |
| 72 1267 631 (R) |                 |

## Window handles

Custom-coordinated lifting/sliding door handle available upon request, see page 10



- 34 1267 09030 (rose 27 × 62 × 10)
- 34 1267 09039 (rose 32.5 × 70 × 10)
- 34 1267 09034 (rose 25.5 × 60.5 flush-fitted)
- 34 1267 170 (lock adaptor RC 1–6)
- 34 1267 076 (lock adaptor with push-button RC 1–6)
- 34 1267 711 (plug-in handle for timber/metal profiles, Ø 30)
- 34 1267 751 (plug-in handle for PVC profiles, Ø 30)

N = non-handed  
 R = DIN RH, opening inwards  
 L = DIN LH, opening inwards  
 ILS = inactive-leaf set

Female handles  
 Plug-in handle for doors  
 FSB ASL®  
 FSB AGL®  
 FS heavy-duty fitting  
 EN 179 heavy-duty fitting

For bearings, see page 52 ff.