

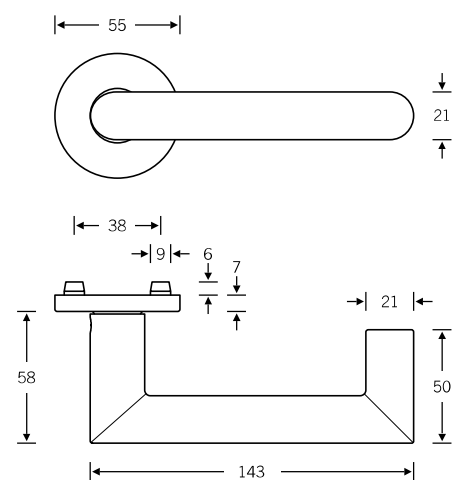

The 1076 model FSB launched in 1990, a lever handle design with its roots in the 1920s, became the most copied lever handle of the century. The version shown here, the FSB 1016, is a more enclosed counterpart to it.



 EN 179 model:
Lever handle with return-to-door

Other variants:
 – square roses
 – oval/angular backplates

Plug-in handle for doors

15 1016

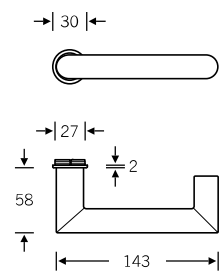

4

Window handle

Plug-in handle for windows

34 1076

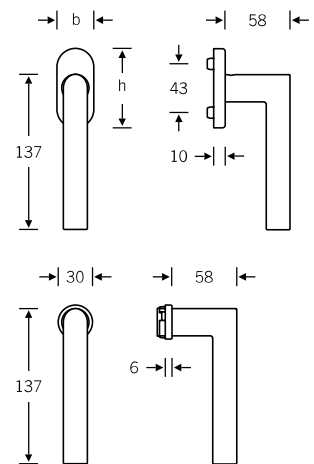

Lifting/sliding door handle

34 1016 011

For more variants, see page 443
For parallel slide/tilt fitting, see page 439

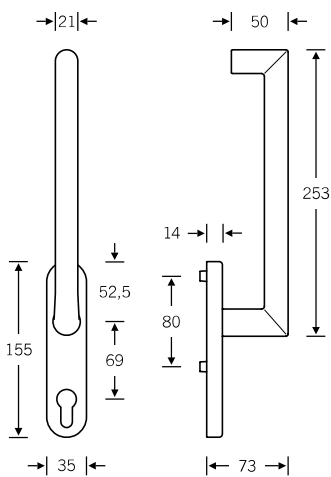

Lever handles
for narrow-stile doors



09 1016 (in-line, EN 179)
06 1016 (cranked, EN 179)

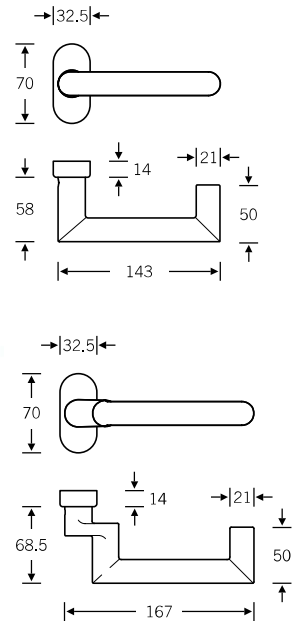

Doorknob
for narrow-stile doors

07 0809 (cranked)

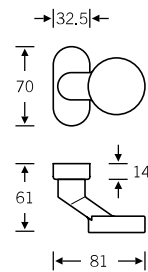

Glass door fitting

13 4220 with 72 1016

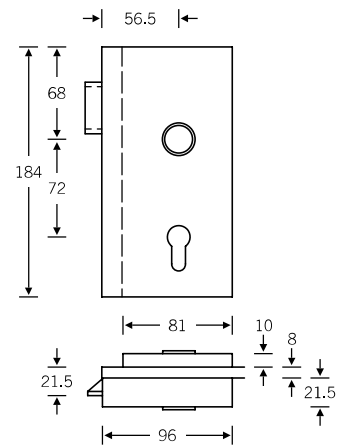

4

Lever/knob sets

Doorknob for flush doors

Knob backplates

- Aluminium $\varnothing = 50$
- Stainless steel $\varnothing = 55$
- Bronze $\varnothing = 50$

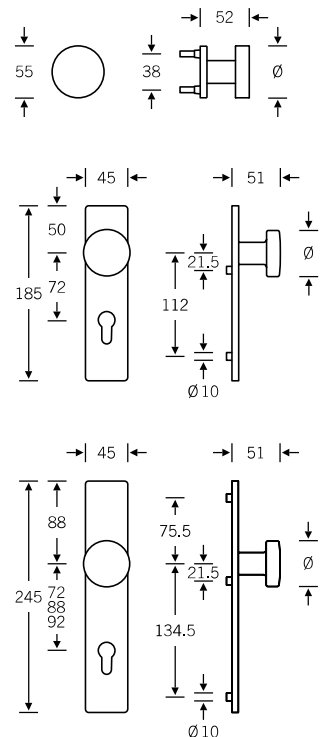

Product codes for the lever/knob sets can be found on the following pages; for individual components, see page 328 ff.

Lever/lever sets

Broad backplate sets available upon request; for flush-fitted roses, see page 386 f.

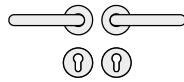

- 12 1016 013 (N)
- 72 1016 613 (R)
- 79 1016 613 (R)

- 72 1016 614 (L)
- 79 1016 614 (L)

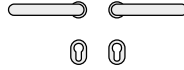

- 15 1016 013 (N)

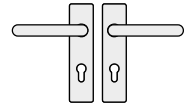

- 12 1016 001 (N)
- 72 1016 601 (R)
- 79 1016 601 (R)

- 72 1016 602 (L)
- 79 1016 602 (L)

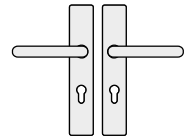

- 12 1016 021 (N)
- 72 1016 621 (R)
- 79 1016 621 (R)

- 72 1016 622 (L)
- 79 1016 622 (L)

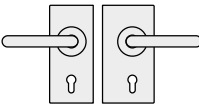

- 13 4220 041 (R) with 10 1016 00500 (N)
- 13 4220 042 (R) with 12 1016 013 (N)
- 13 4220 042 (R) with 72 1016 613 (R)*
- 13 4220 090* with 79 1016 913 (N)

- 13 4220 051 (L) with 10 1016 00500 (N)
- 13 4220 052 (L) with 12 1016 013 (N)
- 13 4220 052 (L) with 72 1016 614 (L)*

Sets for narrow-stile doors



- 09 1016 211
- 09 1016 212
- 09 1016 223 (ILS)

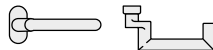

- 06 1016 111
- 06 1016 112

- 06 1016 023 (ILS)



- 07 0809 228 (fixed; aluminium and stainless steel)
- 07 0809 228 (fixed; stainless steel)
- 07 0809 428 (fixed; aluminium)



- 17 1757

* Fire safety and EN 179 variants available only in stainless steel; for variants, see page 508

Lever/knob sets

Broad backplate sets available upon request

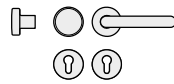

- 12 1016 017 (N)
- 72 1016 617 (R)
- 79 1016 617 (R)
- 79 1016 619 (ILS)
- 72 1016 618 (L)
- 79 1016 618 (L)

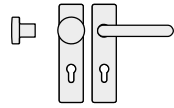

- 12 1016 003 (N)
- 72 1016 603 (R)
- 79 1016 603 (R)
- 79 1016 605 (ILS)
- 72 1016 604 (L)
- 79 1016 604 (L)

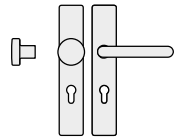

- 12 1016 023 (N)
- 72 1016 623 (R)
- 79 1016 623 (R)
- 79 1016 625 (ILS)
- 72 1016 624 (L)
- 79 1016 624 (L)

WC sets

Broad backplate sets available upon request;
for flush-fitted roses, see page 386 f.

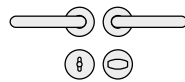

- 12 1016 019 (N)
- 72 1016 619 (R)
- 72 1016 620 (L)

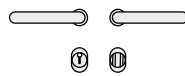

- 15 1016 019 (N)

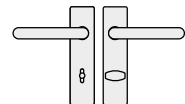

- 12 1016 005 (N)
- 72 1016 605 (R)
- 72 1016 606 (L)

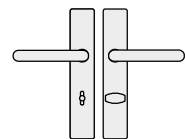

- 12 1016 025 (N)
- 72 1016 625 (R)
- 72 1016 626 (L)

Window handles

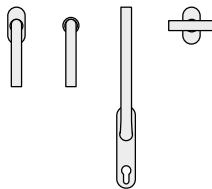

- 34 1076 09030 (rose 27 × 62 × 10)
- 34 1076 09039 (rose 32.5 × 70 × 10)
- 34 1076 09034 (rose 25.5 × 60.5 flush-fitted)
- 34 1076 170 (lock adaptor RC 1–6)
- 34 1076 076 (lock adaptor with push-button RC 1–6)
- 34 1076 711 (plug-in handle, timber/metal profiles, Ø 30)
- 34 1076 751 (plug-in handle for PVC profiles, Ø 30)
- 34 1076 714 (plug-in handle, lock adaptor RC 1–6)
- 34 1076 717 (plug-in handle with push-button RC 1–6)
- 34 3403 (tee handle for window)
- 34 1016 011 (lifting/sliding door handle)

N = non-handed
R = DIN RH, opening inwards
L = DIN LH, opening inwards
ILS = inactive-leaf set

Female handles
Plug-in handle for doors
FSB ASL®

FSB AGL®
FS heavy-duty fitting
EN 179 heavy-duty fitting

For bearings, see page 52 ff.